

TEXTILE

DYEING
FINISHING
PRINTING



MACHINERY

MODERN MACHINES
FOR YOUR FABRICS.



MEMNUN

An aerial photograph of a dense, vibrant green forest. A dark, winding river or stream flows through the center of the forest, creating a meandering path. The trees are thick and cover the entire landscape. The overall scene is bright and natural, emphasizing environmental friendliness.

NATURE FRIENDLY PRODUCTION FOR YOUR FABRICS.

ABOUT US.

WE NEVER GAVE UP FROM OUR VALUES THAT MAKE US.

Sustainable service is the motto of Memnun Machine, which means our business doesn't end after selling the product, we give service to our customers as long as they need. Our goal is to make our customers and business associates satisfied.

Memnun Machine has a good place in the sector with products sold to worldwide.



CONTENTS.

DYEING.

High Temperature Jigger	_06
Atmospheric Jigger	_07

FINISHING.

Raising	_10
Shearing	_11
Combing	_12
Brushing for Woven	_14
Brushing for Woven & Knitted	_15
Sueding & Emerizing	_16
Drying Cylinders	_18

PRINTING.

Screen Engraving Department	_22, 23
Printing Color Kitchen	_24, 25

*Specifications and all datas contained are purely indicative and may be change by the manufacturer.

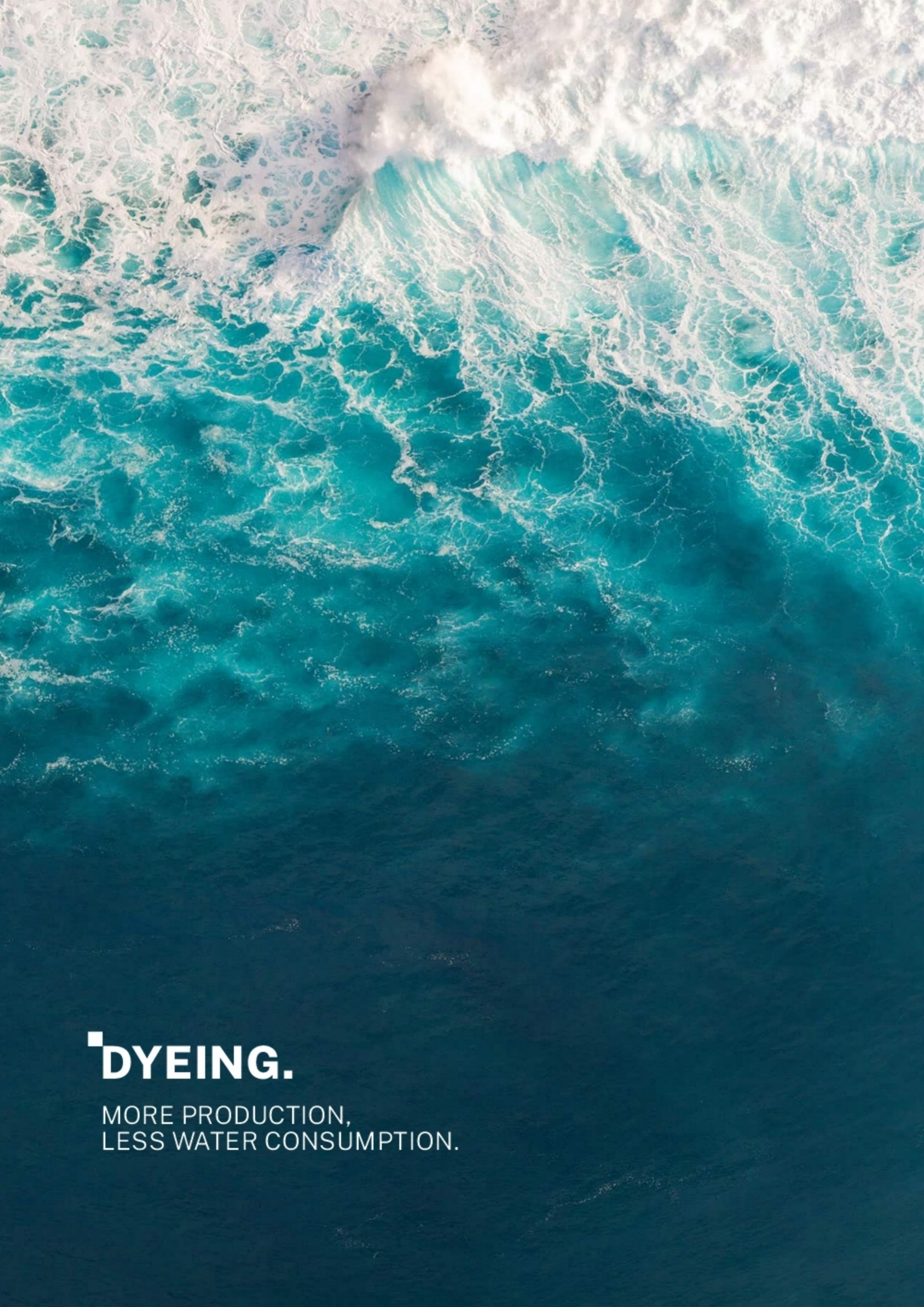

DYEING.

MORE PRODUCTION,
LESS WATER CONSUMPTION.

HIGH TEMPERATURE JIGGER

For more
information



Constant speed and constant tension throughout the whole process

- Polyester and mix, Nylon, Viscose and Cotton Fabrics are dyeing with constant speed by keeping constant tension by low water consumption.

In addition to dyeing, all pre-finishing operations such as bleaching, washing, desizing, scouring can be done.

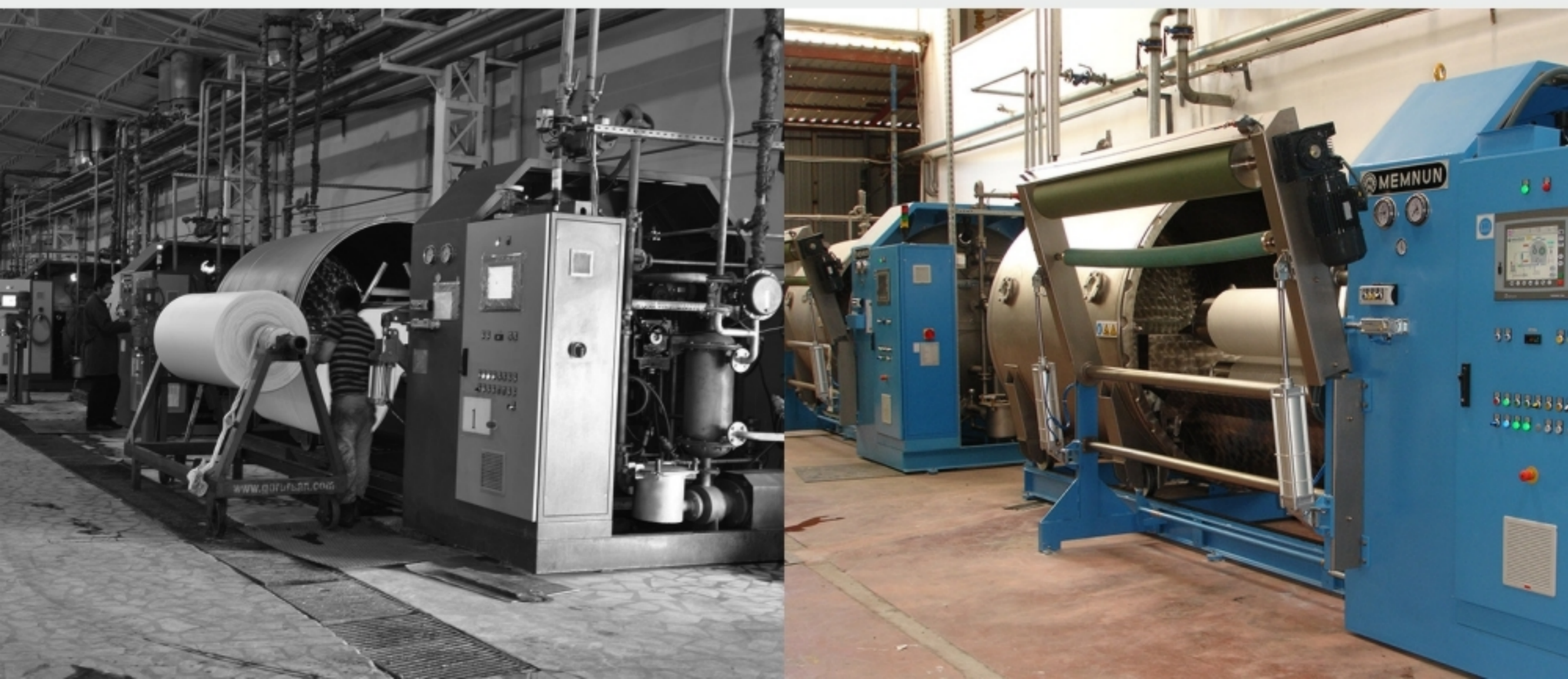

ATMOSPHERIC JIGGER

For more
information



Dyeing and more!

- desizing
- scouring
- bleaching
- dyeing
- washing

Provides to dye Nylon, Viscose, Cotton and its blends with low water consumption, constant tension and constant speed with reaching 98°C temperature.

In addition to dyeing, it is possible to perform all pre-finishing processes such as desizing, scouring, bleaching, washing in the jigger.

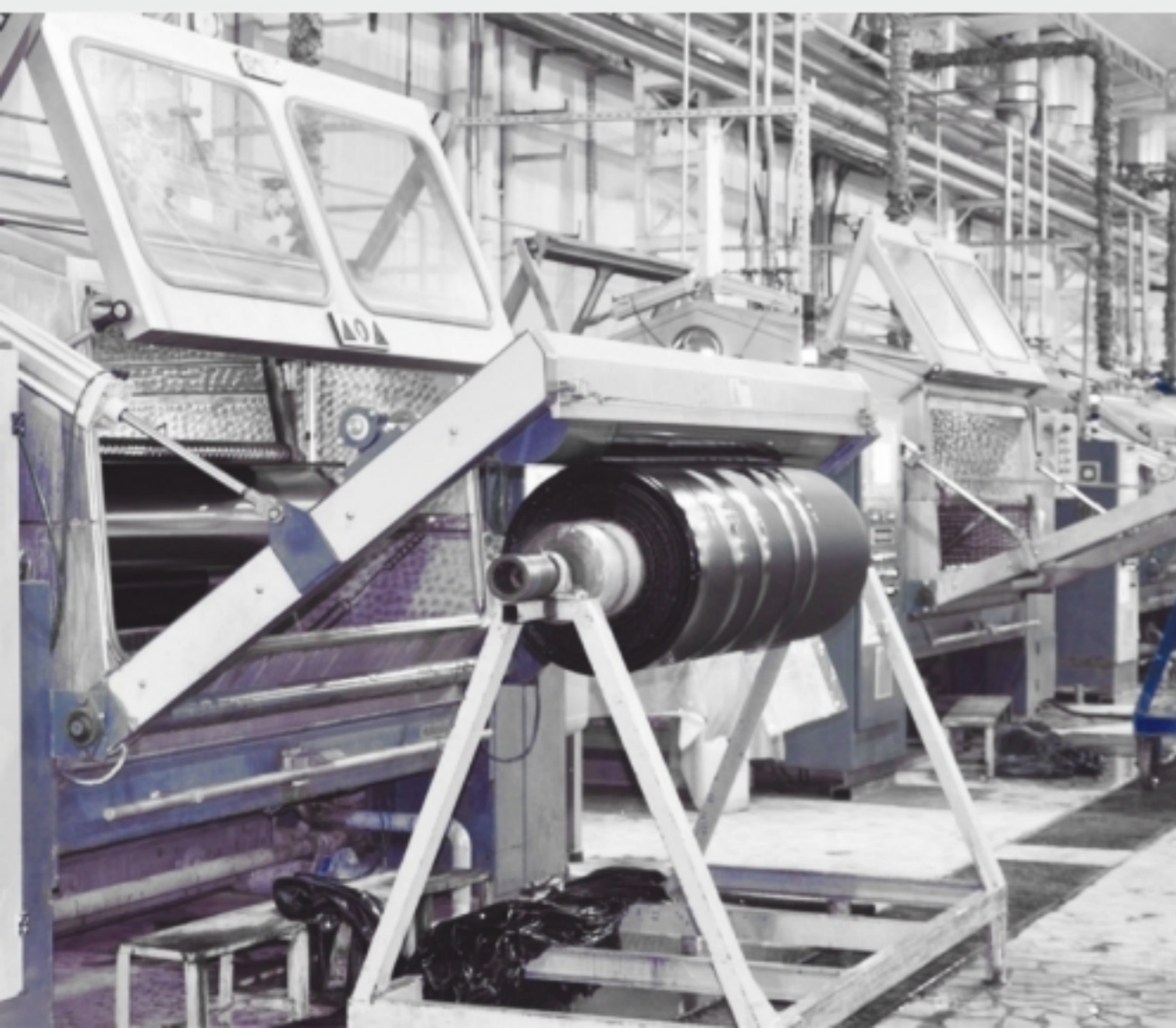

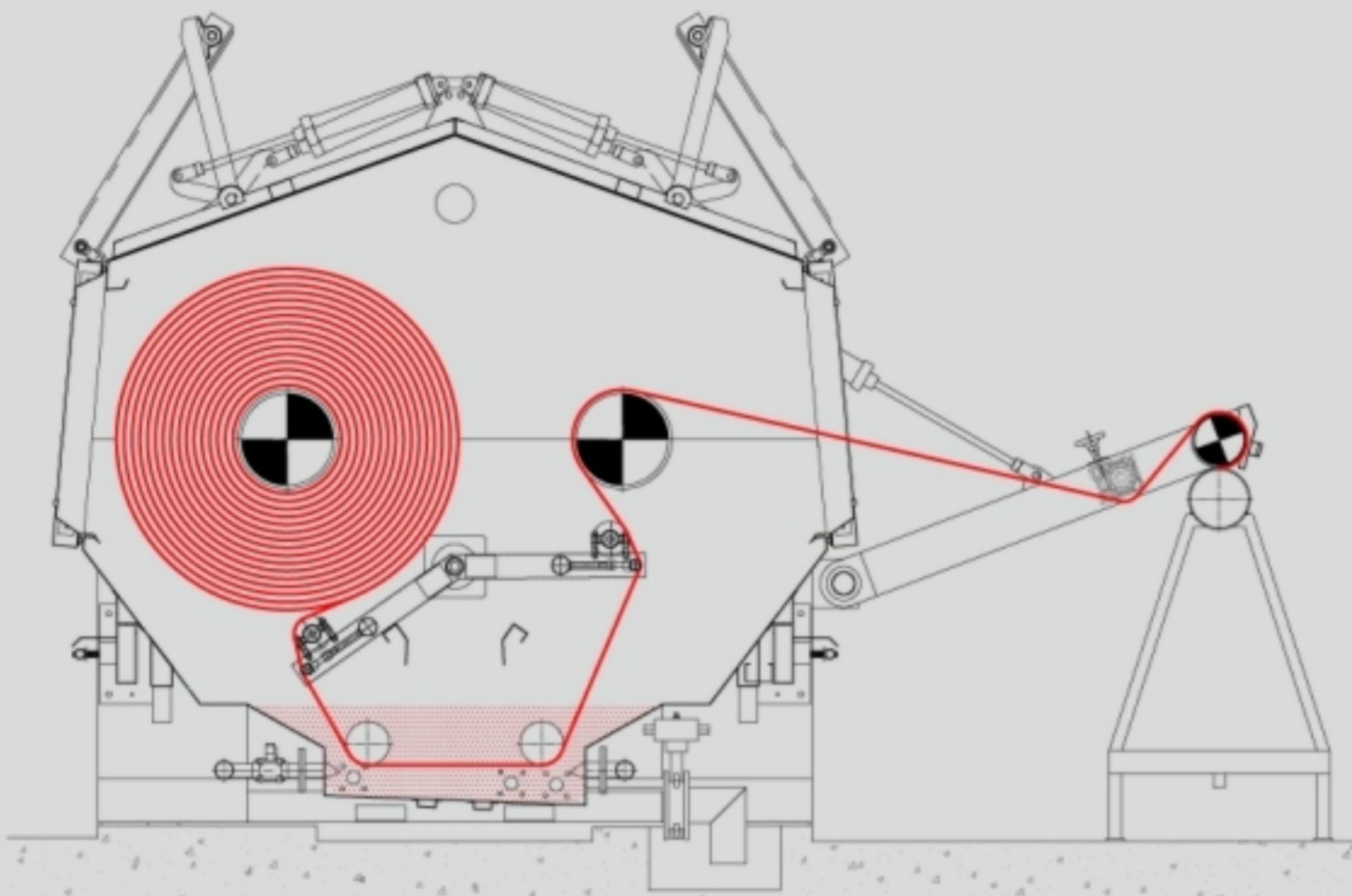

ATMOSPHERIC JIGGER FABRIC PROCESSING

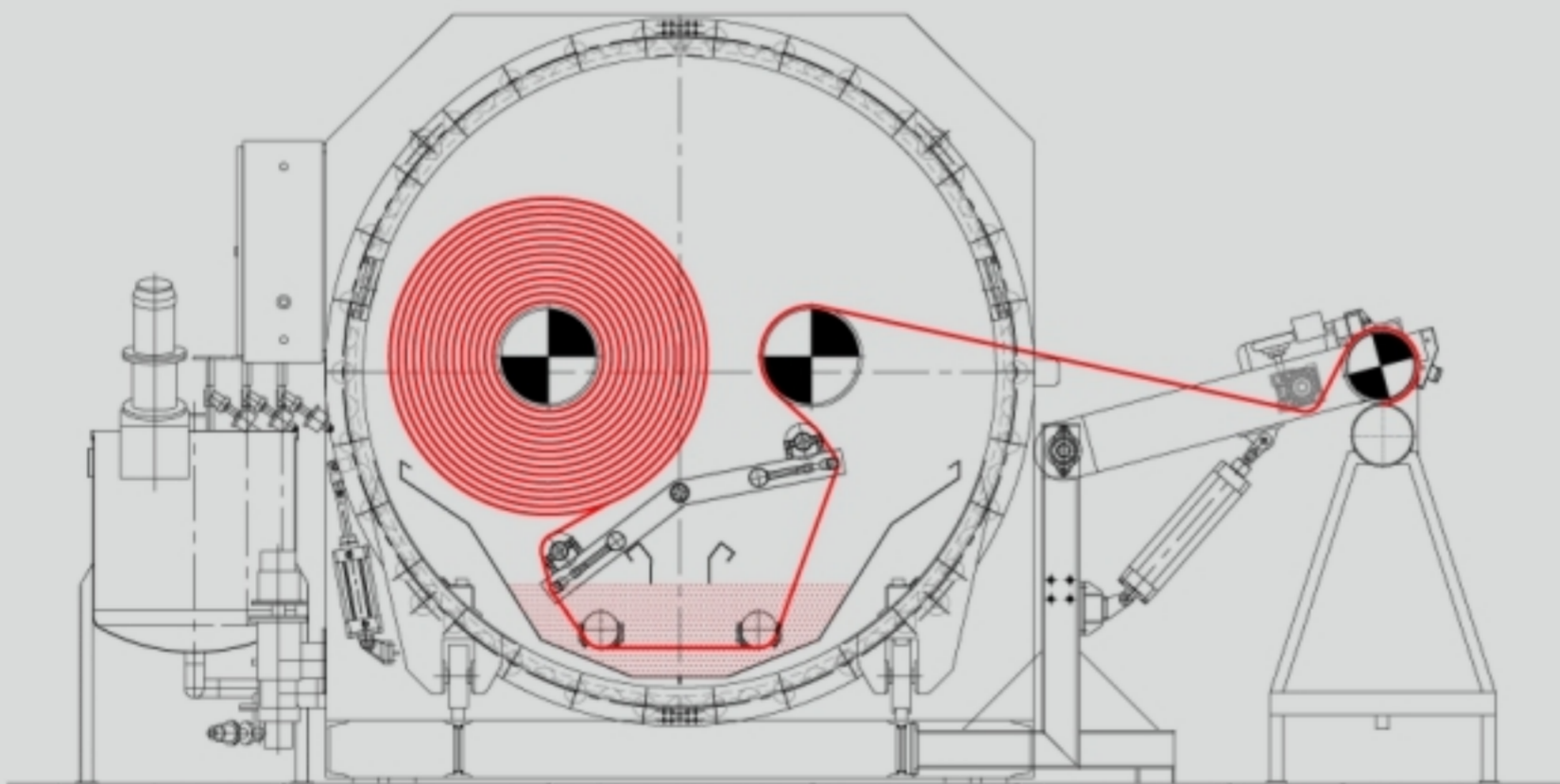

HIGH TEMPRATURE JIGGER FABRIC PROCESSING



FINISHING.

MORE PRODUCTION,
MORE PERFECT EFFECTS.

RAISING

For more
information



Effect is our
profession!

- Suitable for processing all type of fabrics made from synthetic or natural fibre.
- Suitable for open width and tubular fabrics.
- Pile and Counterpile rollers speed can be adjusted individually.

- **Continuous Raising Lines** with different combinations.
 - 24 or 28 rollers
 - Single or double drum
 - Tandem lines

Raising
Line

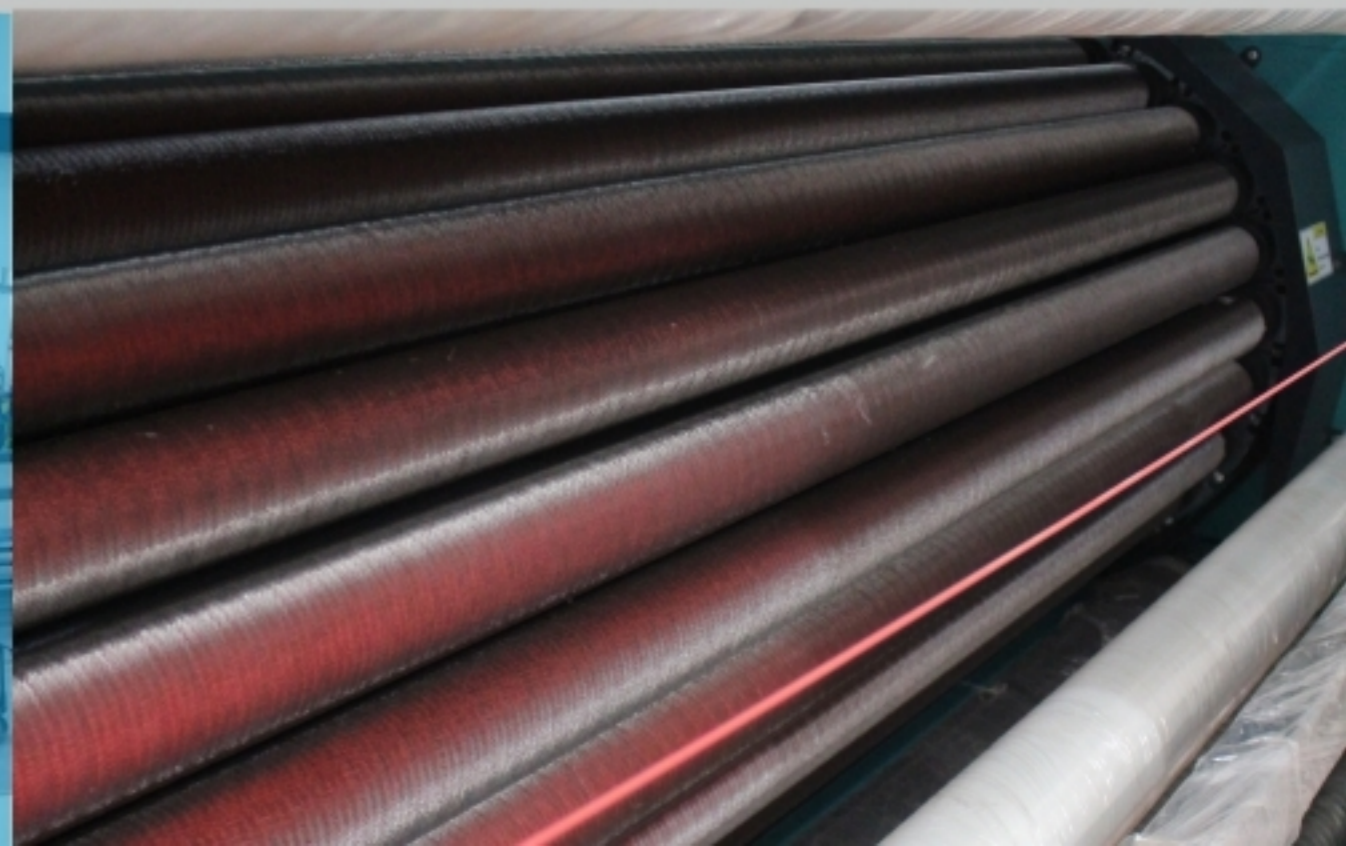

SHEARING

For more
information



Shearing solutions for your fabrics!

The toughest fibers can be sheared easily.
High speed without losing quality.
Possibility of shearing the shortest and finest fibers.

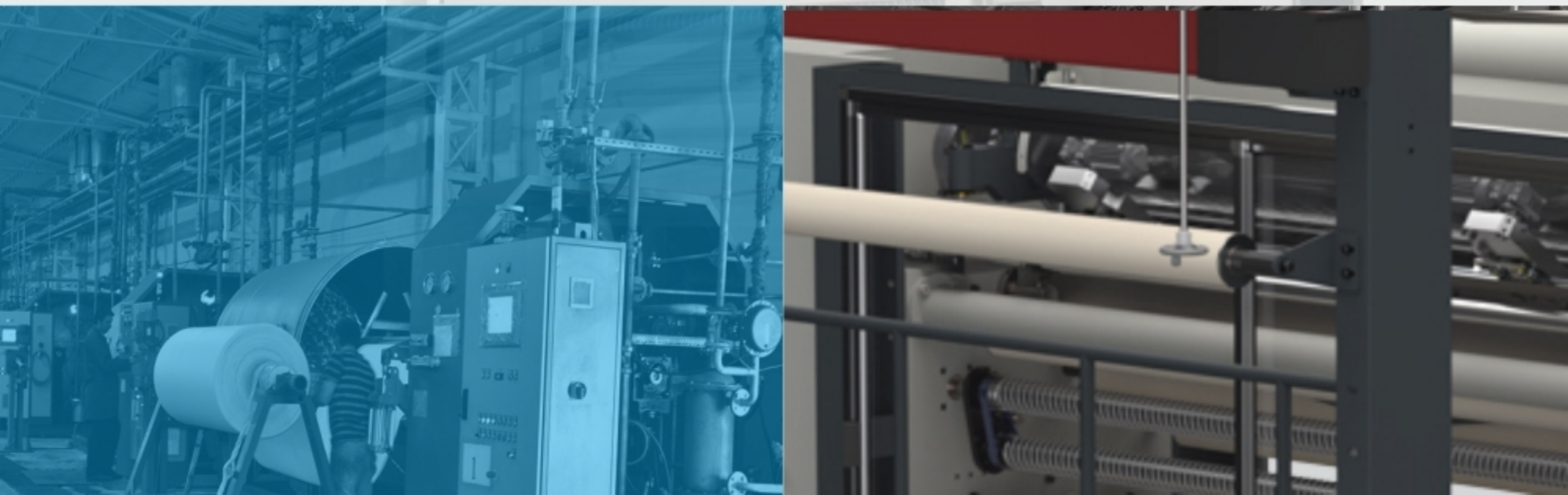

COMBING

For more
information



Combing machine for your fabrics!

Drum tension control from 4 different points with inverter controlled driving rollers
Both for wellsoft and polar fleece fabrics.

- Can be used as a single drum raising machine.

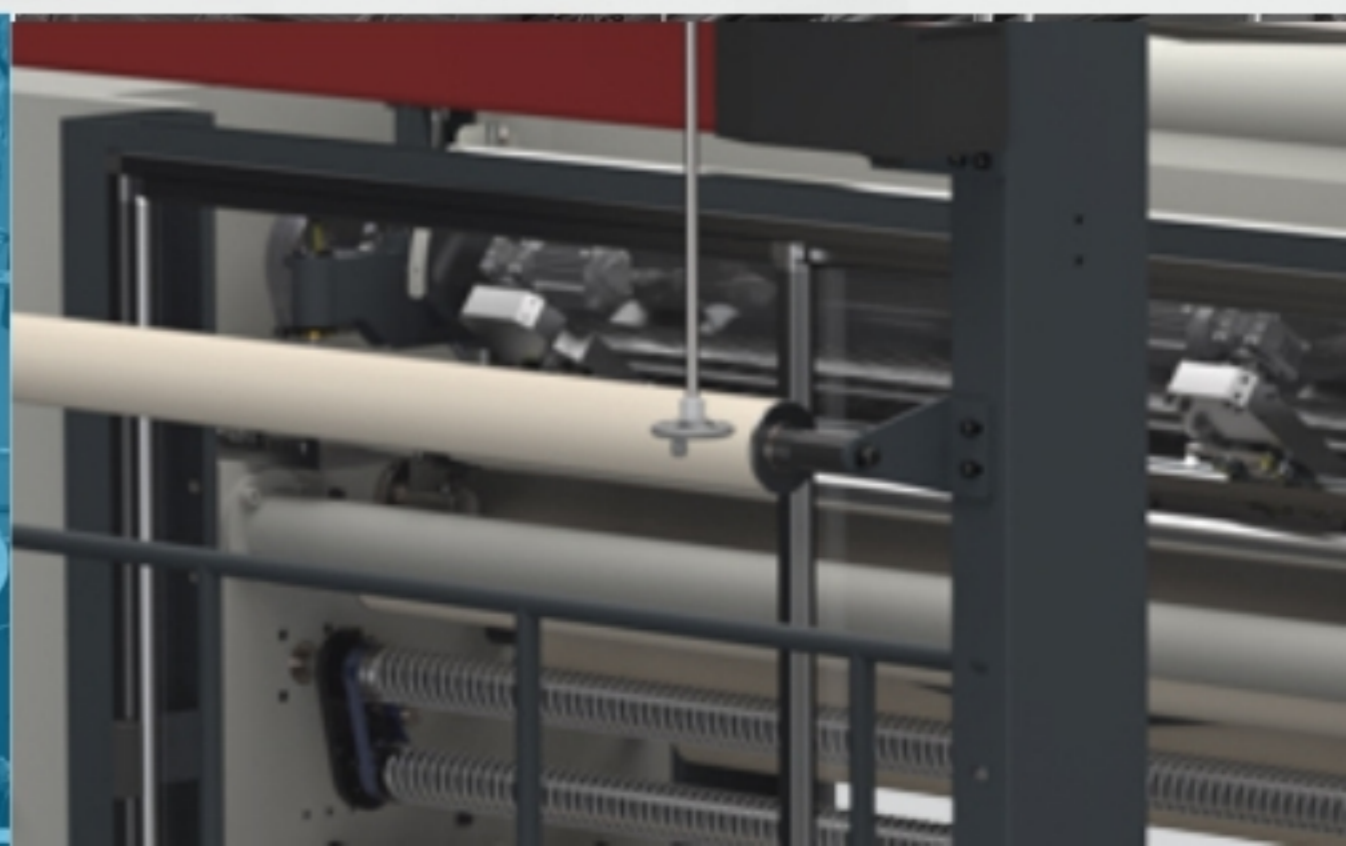

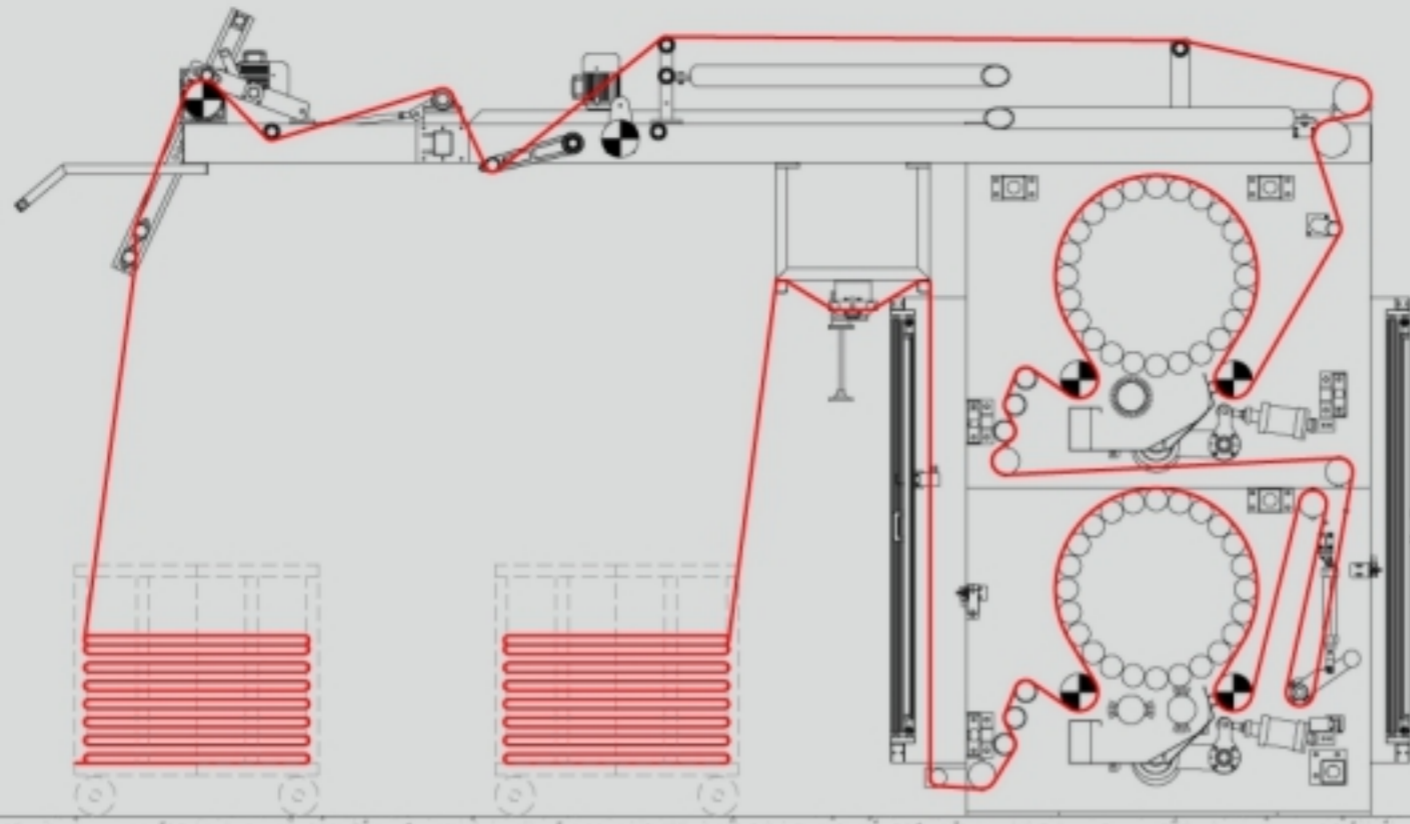

RAISING FABRIC PROCESSING

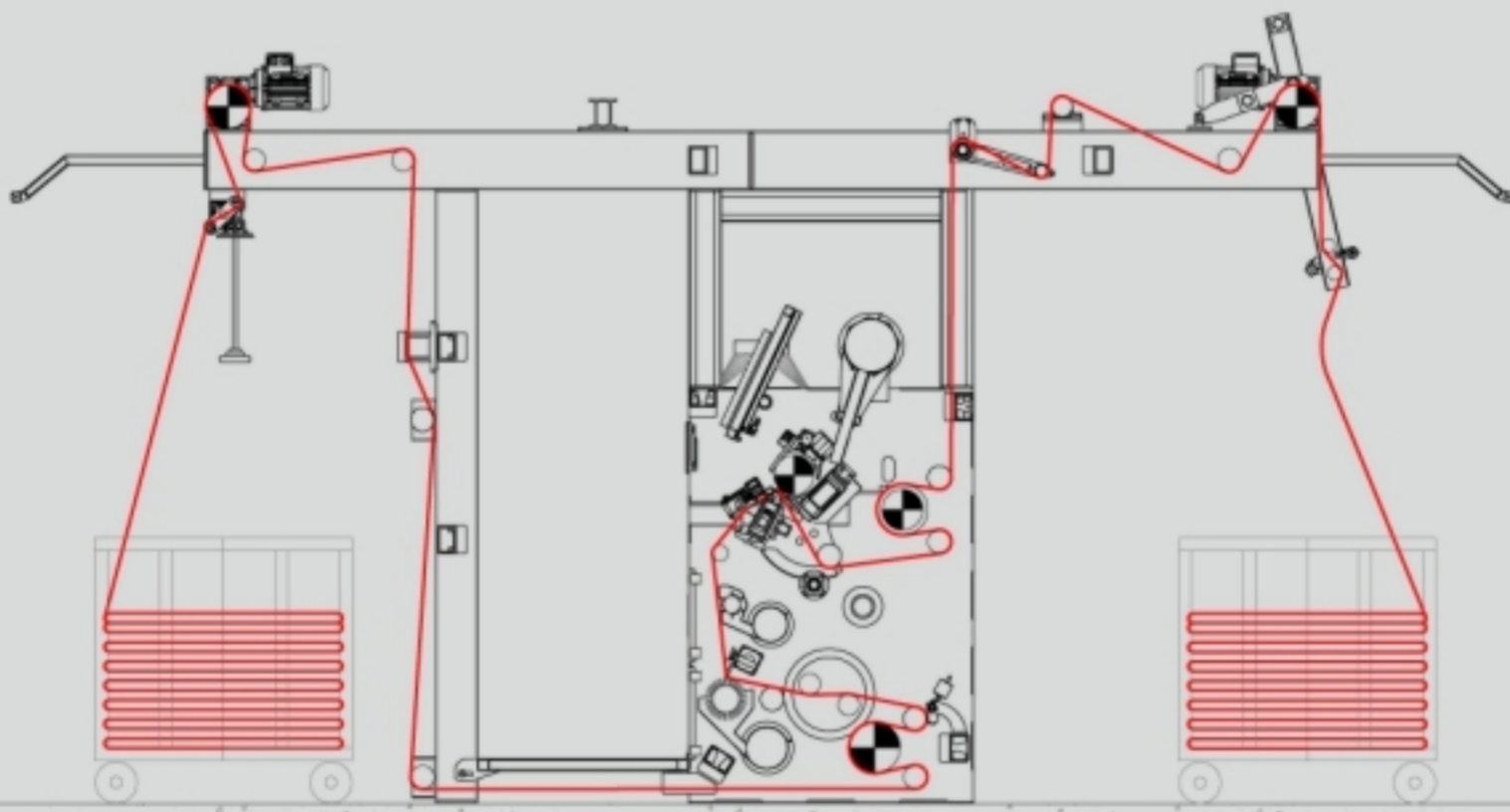

SHEARING FABRIC PROCESSING

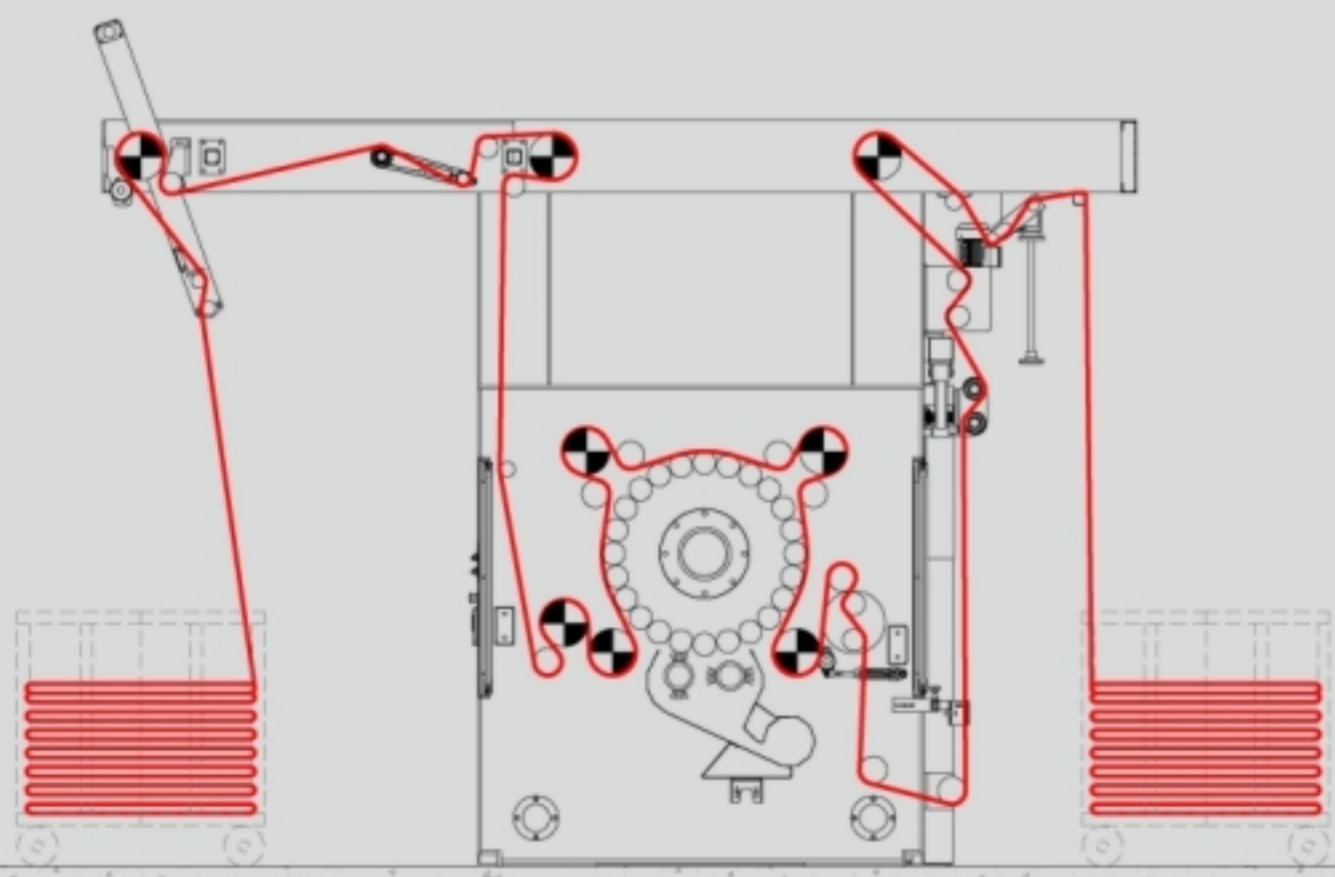

COMBING FABRIC PROCESSING

BRUSHING FOR WOVEN

For more
information



Sueding effects for woven fabrics!

“MELISA”, which is produced with the experience of Memnun Machine in Brushing, can satisfy hard-to-appreciate customers.

It can brush especially woven, thick and thin fabrics and gives excellent results.



BRUSHING FOR WOVEN & KNITTED

For more
information



Brush effect for knitted and woven fabrics!

New generation "ALISA" Brush Sueding Machine provides to work with CARBON BRUSH or CERAMIC BRUSH.

Thus it is possible to have many different kinds of effects with multiple combinations.

COMBINATIONS_

- Carbon Brush
- Ceramic Brush

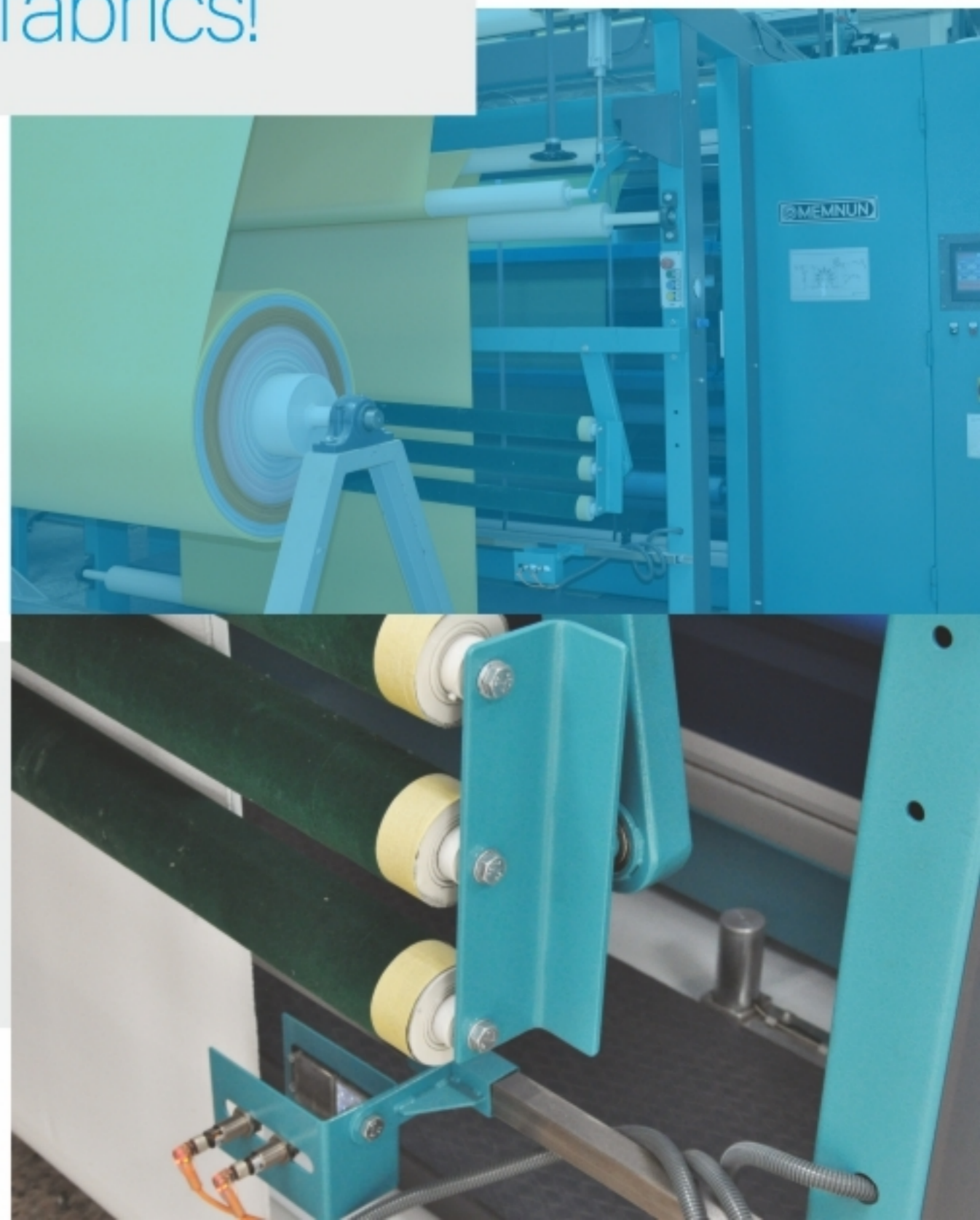

SUEDING & EMERIZING

For more
information



Add value on your fabrics with perfect touch and effects!

It is able to satisfy hard-to-please customers with the experience of Memnun Machine on Sueding.

Especially for Home Textile manufacturers, it has a voice in the sector with the results it obtained in the Horizontal Sueding Machine in upholstery and drapery fabrics.



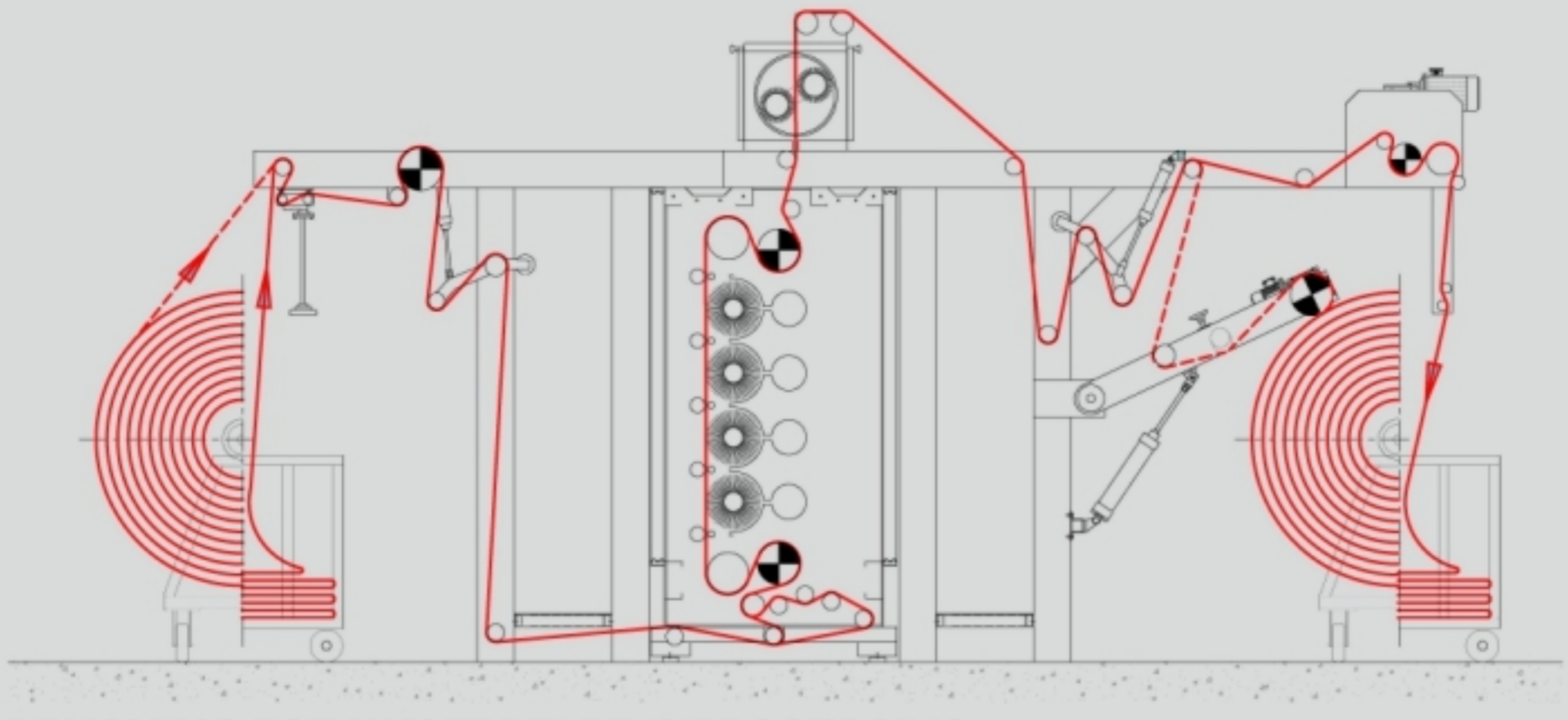

BRUSHING FOR WOVEN FABRIC PROCESSING

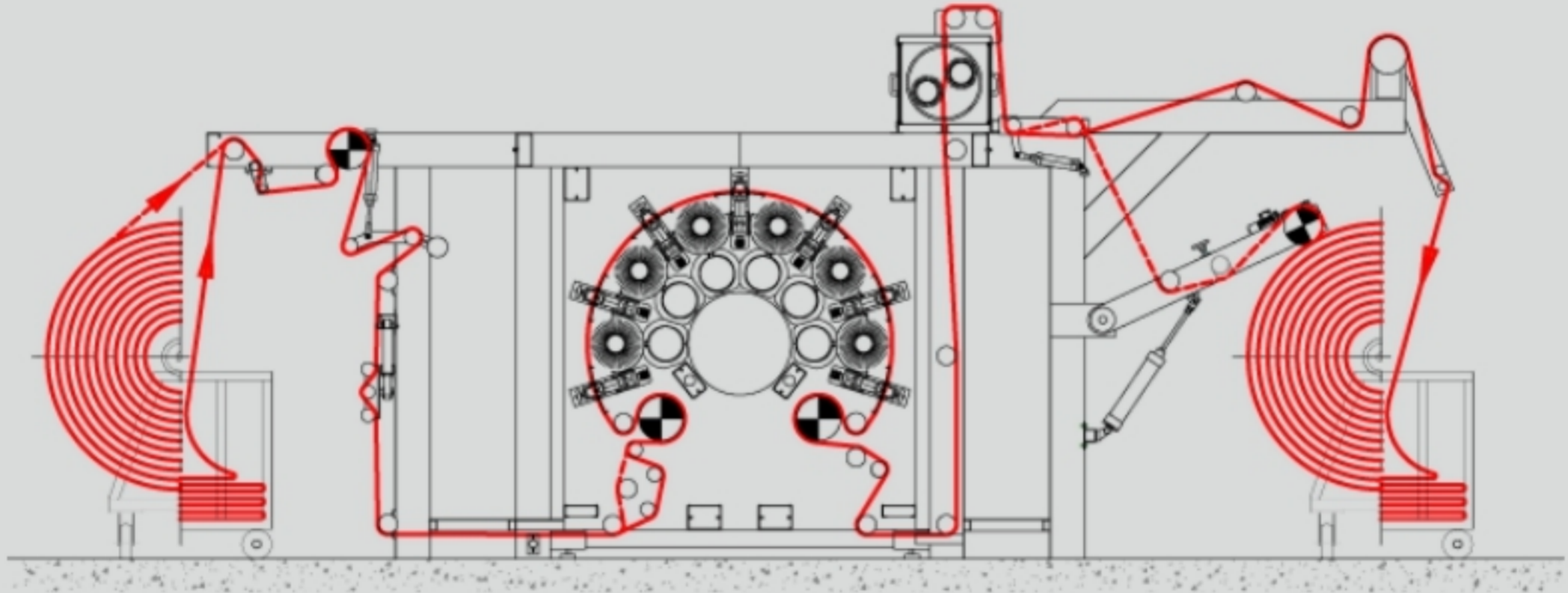

BRUSHING FOR WOVEN & KNITTED FABRIC PROCESSING

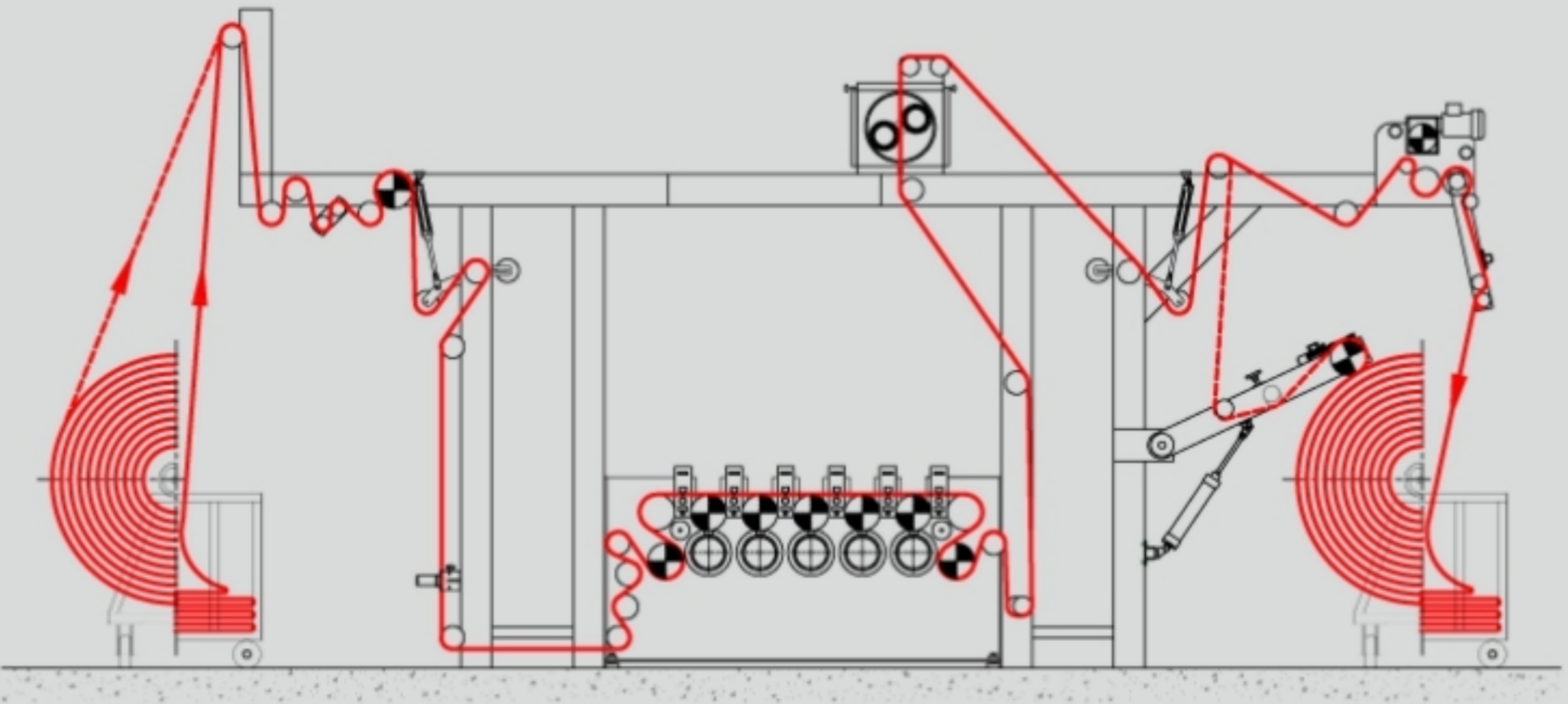

SUEDING & EMERIZING FABRIC PROCESSING

DRYING CYLINDERS

For more
information



Drying Cylinders, Cooling Cylinders.

This machine can be used in all stages of textile finishing. It is used in pre-drying, drying after bleaching, drying after washing lines.

- TUV + CE Certified Drying Cylinders
According to Customer Demands

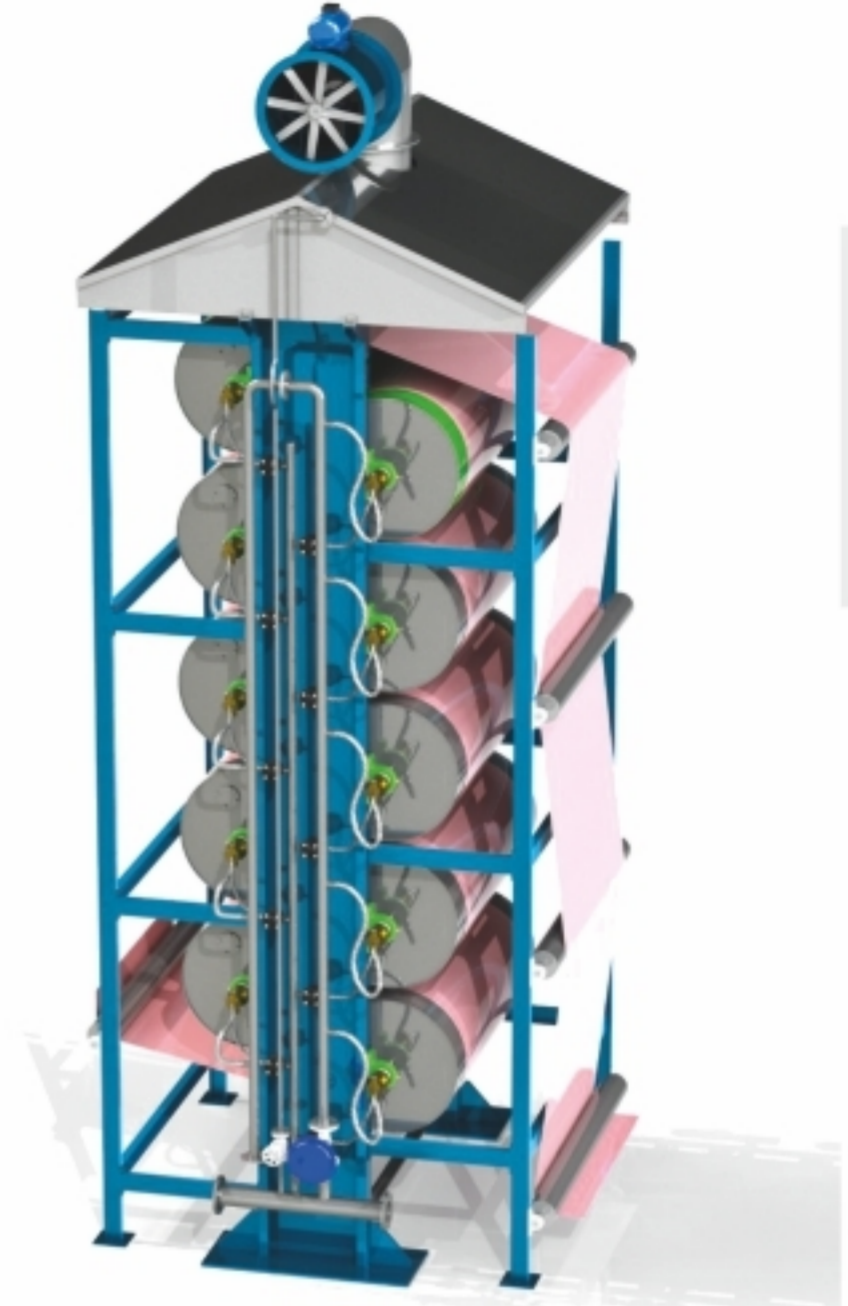

MORE CYLINDERS.
MORE DRY FABRICS.

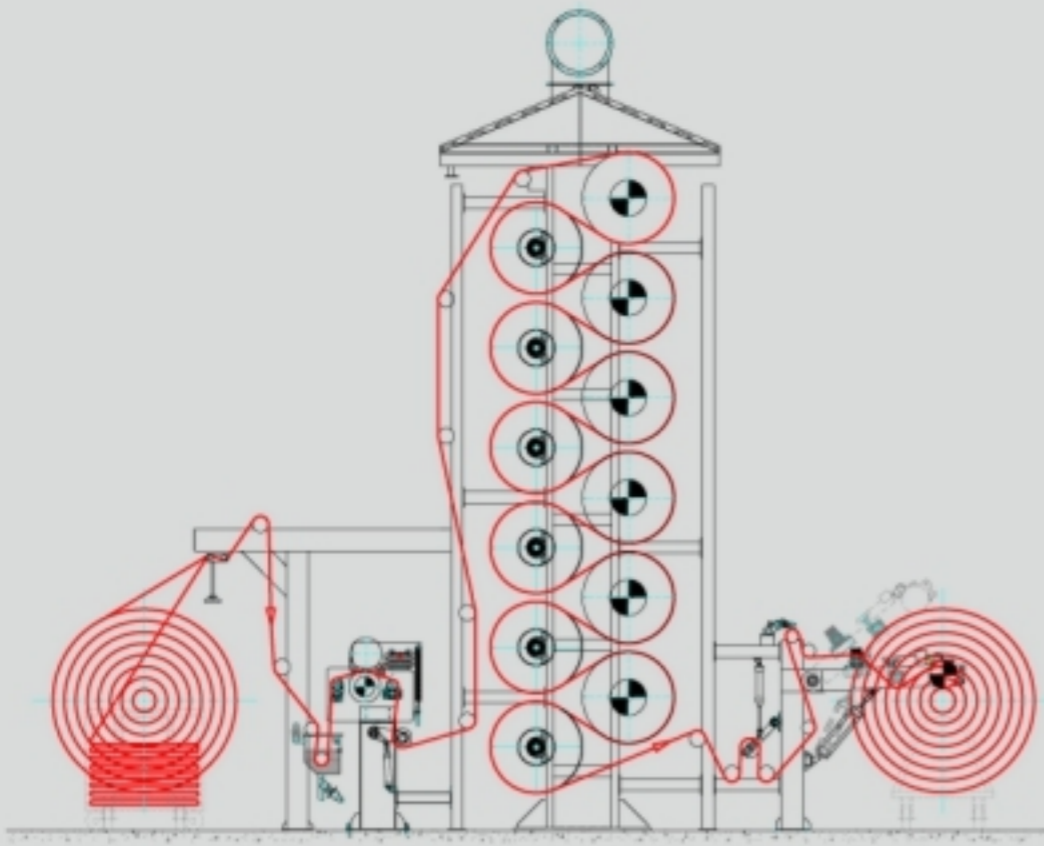

DRYING UNIT WIT SQUEEZING FLOULARD FABRIC PROCESSING

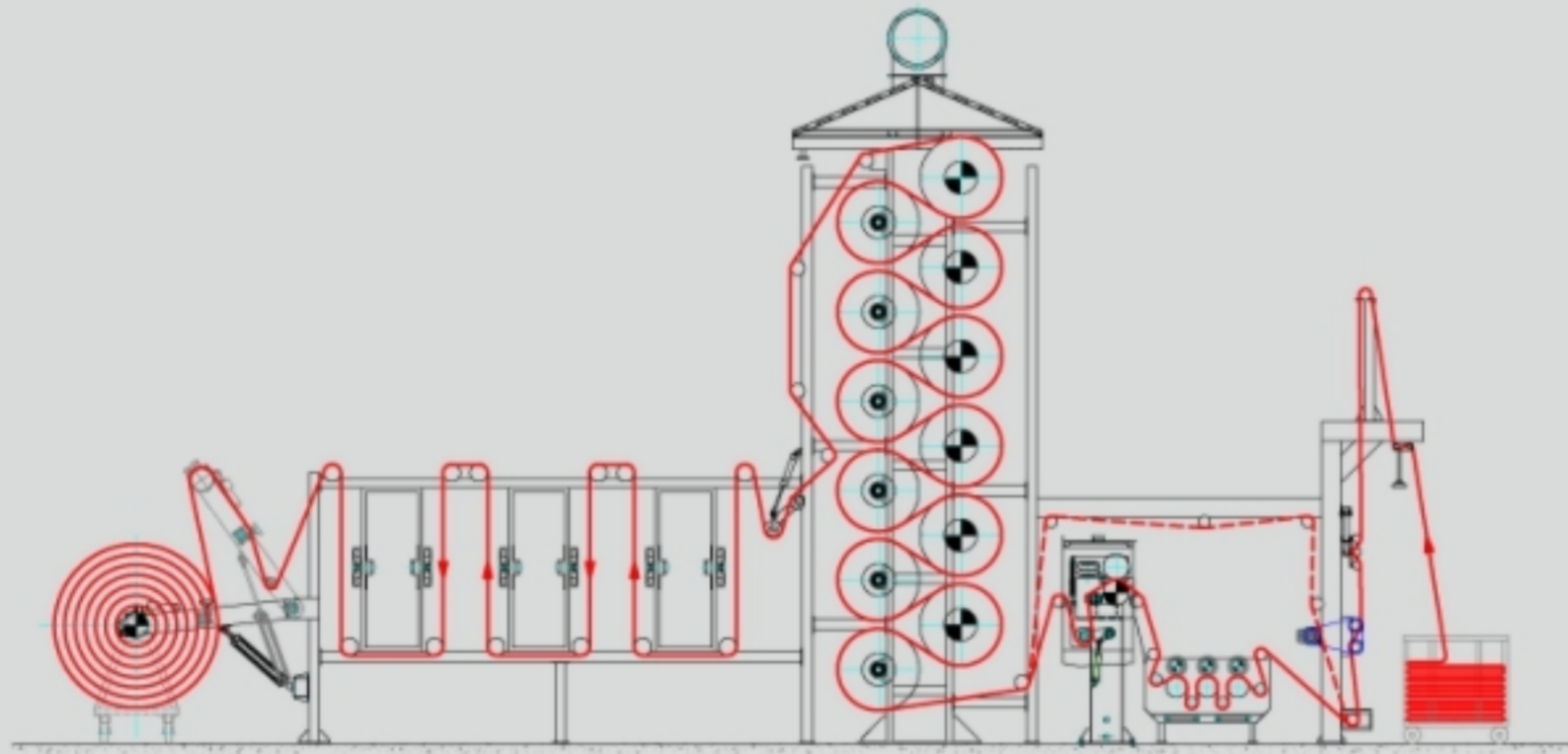

DRYING UNIT (VELVET) FABRIC PROCESSING

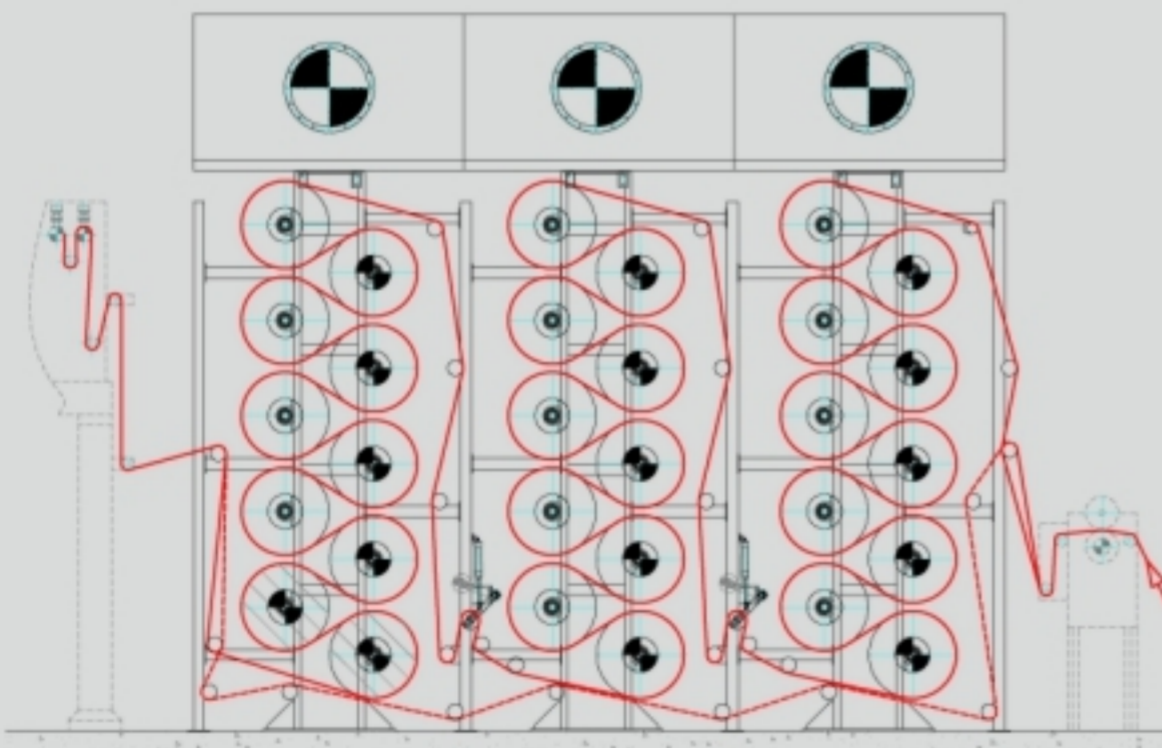

DRYING UNIT (DENIM) FABRIC PROCESSING

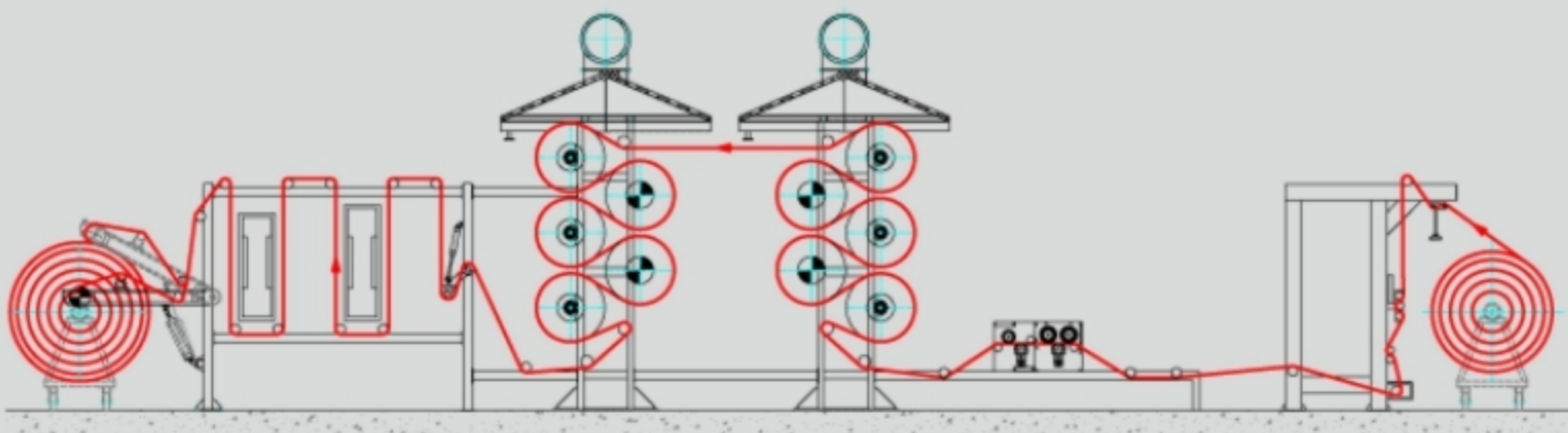

DRYING UNIT (VELVET) FABRIC PROCESSING



EFFECT IS OUR
PROFESSION!

since **1979**



PRINTING.

MORE PRODUCTION,
MORE COLORFUL FABRICS.

SCREEN ENGRAVING DEPARTMENT

For more
information



SCREEN DRYING AND
STORING CHAMBER



LACQUER COATING
MACHINE



POLYMERIZATION
CHAMBER

For repeatedly many times excellent printing.

Rotary Screen Engraving Department Machines.

Printing Widths: 1850 - 2400 - 3200 mm.
Repeat Sizes: 640 + 819 + 914 + 1018 mm.



END RING GLUEING
MACHINE

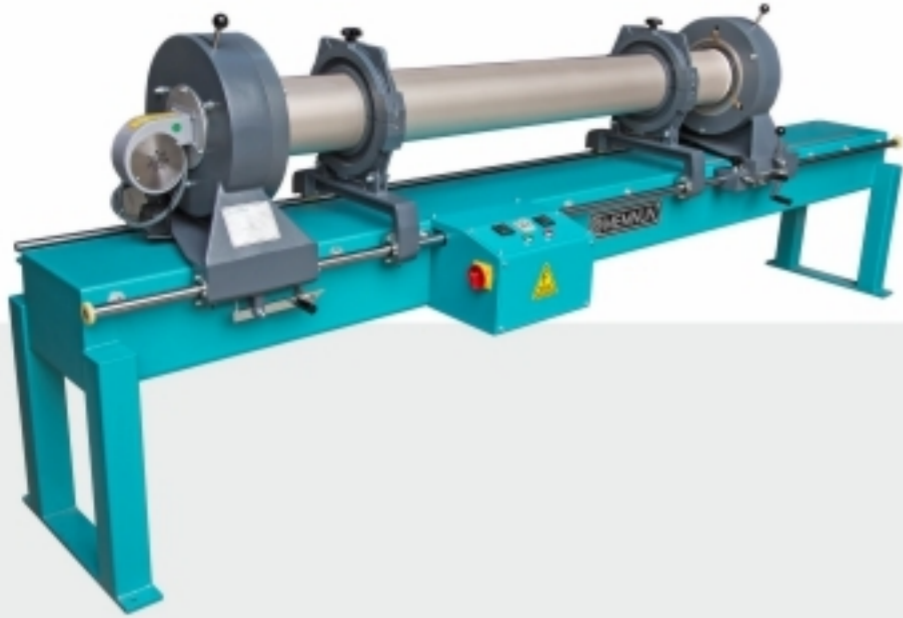

END RING REMOVING
MACHINE



SCREEN WASHING
MACHINE



SQUEEGEE WASHING
MACHINE



All your need together.



PRINTING COLOR KITCHEN

Storage
Tanks



Colorful production
for you!

Printing Color Kitchen designed for your
fabric dyeing.



Fast and less water consumption is the
most advantages for this machines.

EMULSION
PREPARING MIXER



DRUM
WASHING MACHINE



Colors for life,
colors for fabrics.

For more
information

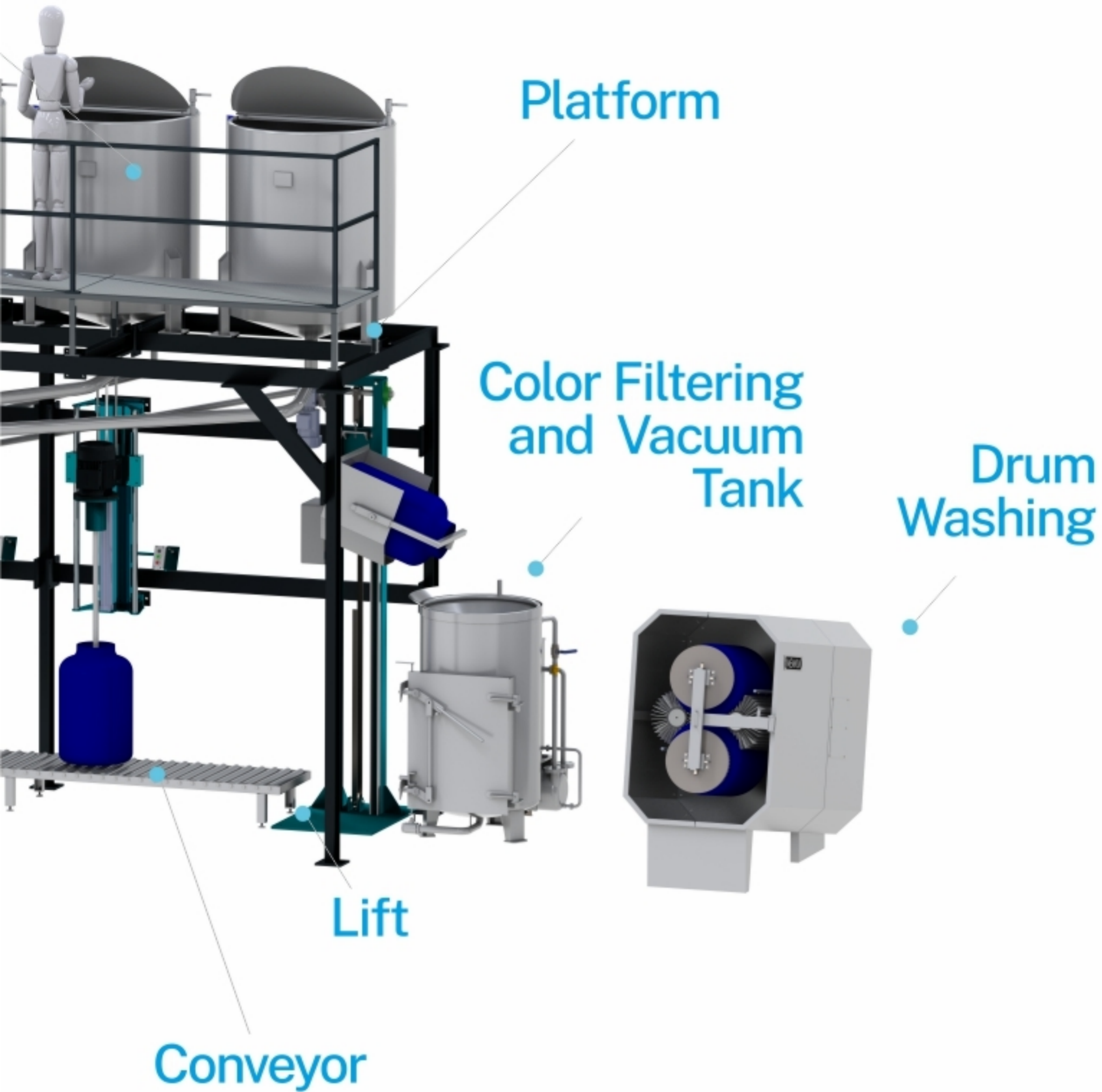

we produce for you
since 1979

www.memnun.com.tr



ISTANBUL FACTORY

Zafer Mahallesi, 118. Sokak, No:10, 34513,
Esenyurt / Istanbul / TURKEY

CERKEZKOY FACTORY

Veliköy OSB Mahallesi, 11. Sanayi Caddesi, No:5/1
Çerkezköy / Tekirdağ / TURKEY

T: +90 212 620 36 20 (pbx) • F: +90 212 620 36 26
www.memnun.com.tr • info@memnun.com.tr

